

NEW

A NEW icon is given to each item of information newly added to this version of glossary.

ALA

5-aminolaevulinic acids (ALA)

ALA is a natural and important amino acid and it has an important role as a raw material used for the production of haem in the blood and chlorophyll in the plant body. It is used as an enhancer of fertilizer to promote plant growth. It is also used in photodynamic cancer therapy, and is expected to be applied in the sectors of pharmaceuticals for both humans and animals and animal feed in areas, such as prevention of anemia in pigs and improvement of disease resistance in fish. The market for ALA is highly expected to grow into a huge one that can be equal to the size of the markets for main amino acids in the future. Cosmo Oil has developed a low-cost method of manufacturing ALA, which is supplied to the fertilizer, animal feed, cosmetics, health food, pharmaceutical, and other markets. At the same time, Cosmo Oil is working with partners on the development and sales of new applications for these markets.

API

The American Petroleum Institute gravity, or API gravity is a measure of the density of a crude oil liquid. If its API gravity value is greater, it indicates that a larger quantity of lighter and more highly value-added distillate products (gasoline, kerosene, jet fuel and diesel fuel) is likely to be distilled from the liquid, which is priced higher in the market.

NEW

Biogasoline

Biofuels, made from plants as raw materials, are eco-friendly fuels since they don't increase CO₂ in the atmosphere, even if they release CO₂ through incineration since plants have already absorbed CO₂ through photosynthesis in the growing process, which is called the "carbon neutral effect". In 2010, the oil industry in Japan has decided to introduce 840,000 kl of ether tertiary butyl ether, or ETBE, which is a fuel produced by mixing ethanol and isobutylene.

CARB Diesel Fuel

It refers to diesel fuel with much less environmental impact, which can meet the rigorous quality standards established by the California Air Resources Board (CARB) of the U.S. The CARB diesel fuel has a lower viscosity level, a higher cetane value and a lower aromatics content than diesel fuels available in Japan.

By securing diesel fuel tanks in California, Cosmo Oil in April 2007 launched its CARB diesel fuel wholesale business in the U.S.

Car Care Merchandise

It includes car inspection, repair, lubricating oil change, and car wash services, tires, batteries, accessories, and other automotive products and services, which represent the value added merchandise.

CM Aromatics Co., Ltd.

A joint venture company established by Cosmo Oil and Maruzen Petrochemical Co., Ltd. to procure the base material to manufacture mixed xylene and to store and market it.

Date of establishment: April 1, 2005
Capital: ¥100 million
Invested by: Cosmo Oil at 65% and Maruzen Petrochemical Co., Ltd. at 35%

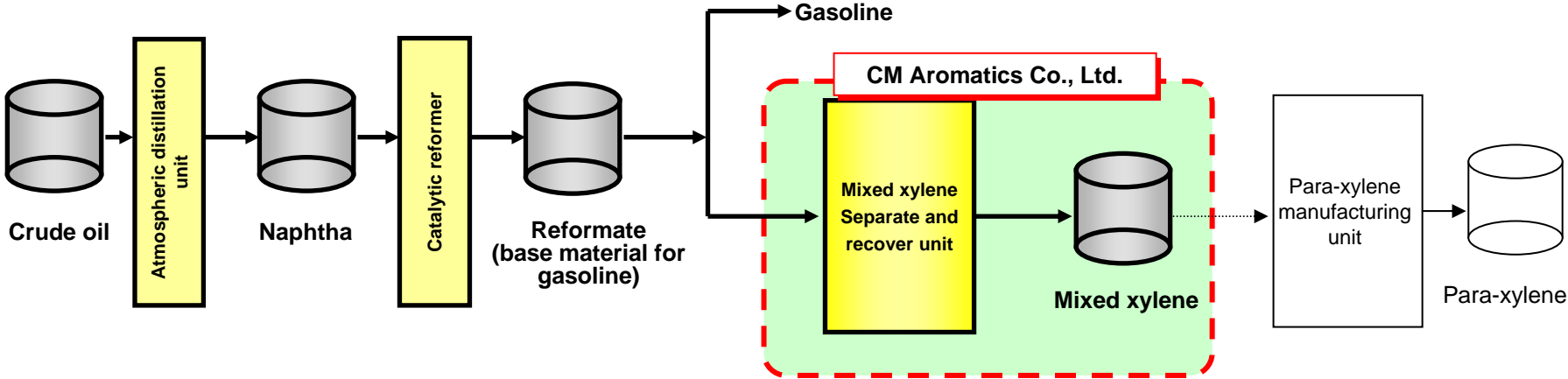

Coker Unit

A new unit built at the Sakai Refinery of Cosmo Oil (with a capital investment of some ¥100 billion) scheduled to start operation during fiscal year 2010. In addition to the Coker unit, a Coker Distillate hydrodesulfurization unit is also newly being built. These units, when completed, will be used to produce naphtha, jet fuel and diesel fuel from an asphalt fraction.

These efforts are expected to provide benefits, such as cost reductions in the refining process by using heavy crude oil (by taking advantage of heavy-lighter crude oil price gaps, or price gaps between heavy crude oil and light crude oil aimed at maintaining the same distillate production rates as conventionally by using lower-priced heavy crude oil) and better responses to structural changes in oil product demand in Japan and higher refining margins with a shift to the production of intermediate fractions from that of a heavy oil fraction (by taking advantage of light-heavy distillate product price gaps, or price gaps between oil product and heavy fuel oil aimed at improving rates of producing more highly value-added lighter distillates), thereby improving profitability at the company.

<Outline of the New Facilities to Introduce>

- (1) Coker unit - Processing capacity of 25,000 BD
- (2) Coker Distillate hydrodesulfurization unit - Processing capacity of 42,000 BD

<Outline of Production Capacity Expected>

Naphtha: 250,000 kl/year; Jet fuel: 700,000 kl/year; Diesel fuel: 350,000 kl/year;
and Petroleum cokes: 400,000 tonnes/year

→Please refer to “Heavy-Lighter Crude Oil Price Gap” and “Light-Heavy Distillate Product Price Gap.”

<Refining Process Chart After Introduction of Coker and Other Units>

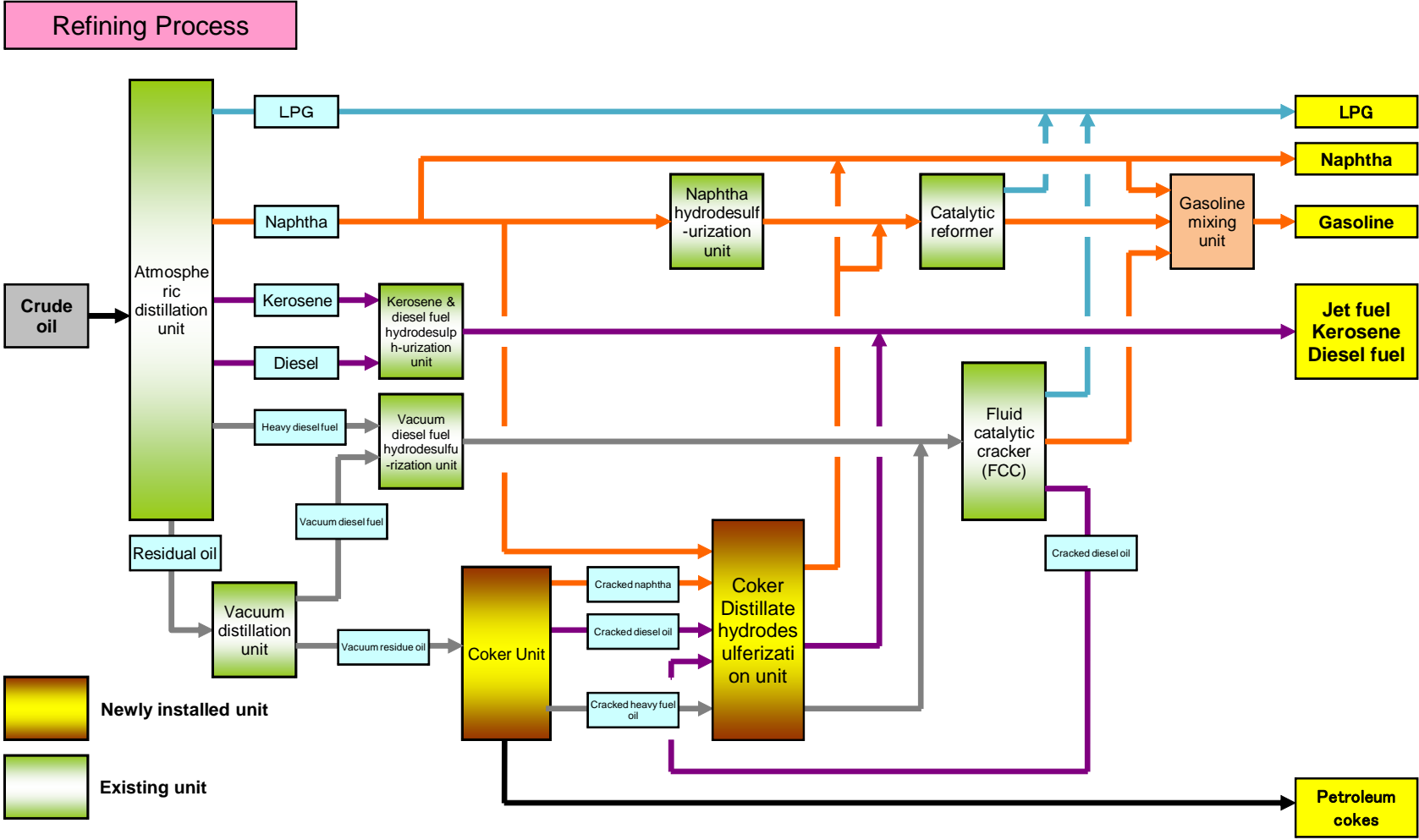

Concentrated Solar Power (CSP) Generation

This technology uses mirrors and other devices to concentrate sunlight to make heat, which creates steam that turns a turbine to generate electricity. It is expected to rapidly grow in the future. Unlike photovoltaic (PV) power generation systems, CSP generation systems use heat, enabling 24-hour power generation. Accordingly, they are drawing much attention as base power sources.

1. Trough System (technology currently commercialized on a large scale):

This system uses semi-cylindrical reflective troughs arrayed on the ground to concentrate light directly in front of the troughs onto slender heat-collecting tubes, through which industrial oil or molten salt is passed and heated. The heat creates steam that turns a turbine to generate electricity.

2. Tower-Top System (technology commercialized in Spain for the first time in the world in 2007):

This system uses reflective mirrors, called heliostats, that track the sun as it moves through the day and reflects the energy to a solar receiver installed at the top of a tower. The concentrated light heats water, producing steam that turns a turbine to generate electricity.

3. Beam-Down System (the newest technology under development; currently under research and development by Cosmo Oil):

This system has evolved from the tower-type technology. Sunlight reflected from a central reflective mirror installed on the top of a tower is collected to a solar receiver on the ground. Placing the solar receiver on the ground is expected to reduce both tower construction costs and solar receiver operating costs.

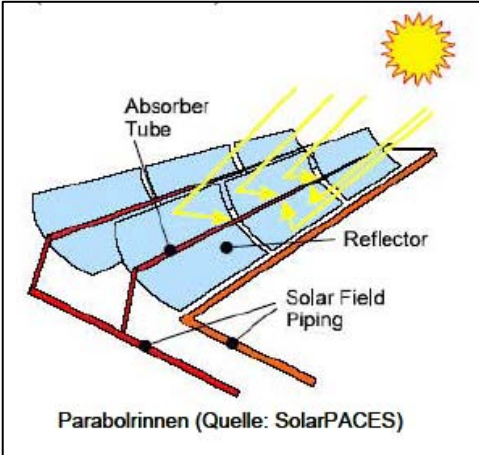

1. Trough System

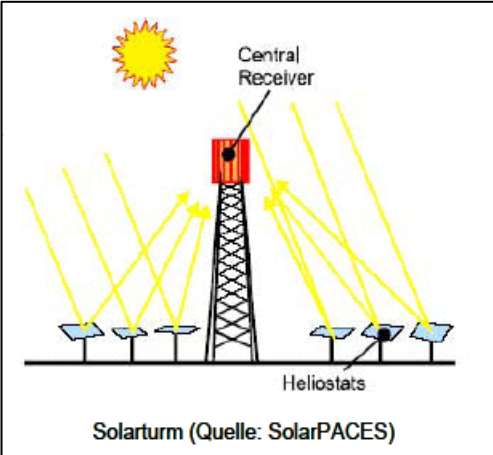

2. Tower-Top System

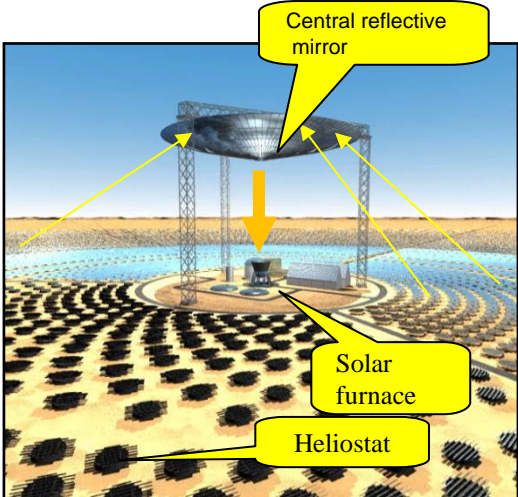

3. Beam-Down System

Cosmo The Card House

Cosmo Oil's proprietary credit card that is available only at Cosmo Oil SSs.

The card provides great benefits for the three parties customers, dealers (SSs) and Cosmo Oil, respectively, as follows:

- Customers: Issuing cards immediately, cashless payment for purchases at the service station (SS), redemption of premiums (please refer to the section Mileage, Mile –Cosmo Gasoline Mileage), cash loans and many other benefits are available.
- SS: Actively issue new cards at the time of SS opening to set up a system so that customers will come back to Cosmo SSs and use the cards repeatedly.
- Marketing activities by utilizing POS (point of sales) data gathered through card use would help dealers enhance the ways they operate their SSs and increase sales.
- The card also makes it easy for SSs to process customer payments and offers the issuer's commission lower than credit sales companies'.
- Cosmo Oil: Enhancement in marketing tools and SS management is expected to bring more sales and more card commission revenues.

Cosmo The Card Opus

Starting June 2006, "Cosmo the Card Opus" was issued in affiliation with AEON Credit Service Co. Ltd.

Co-branded with no annual fee international brands (VISA, MasterCard, JCB), the line-up will be able to accommodate a range of customer needs.

Cosmo The Card Triple

A credit card issued through a tie-up with a credit card company

Desulfurization Catalyst

The typical desulfurization process is such that sulfur (S) is removed in the form of hydrogen sulfide by reacting the sulfur contained in crude oil with hydrogen (H).

A catalyst is used to promote this chemical reaction.

Eco Card

Cosmo Oil's proprietary credit card providing an opportunity for its cardmembers to "participate in environmental preservation" activities in addition to the same features offered by Cosmo The Card Opus and Cosmo The Card House. Two "Eco" cards are available: Cosmo The Card Opus "Eco" and Cosmo The Card House "Eco." The Eco Card is designed to acquire new customers highly sensitive to environmentalism in addition to attracting Cosmo The Card targets.

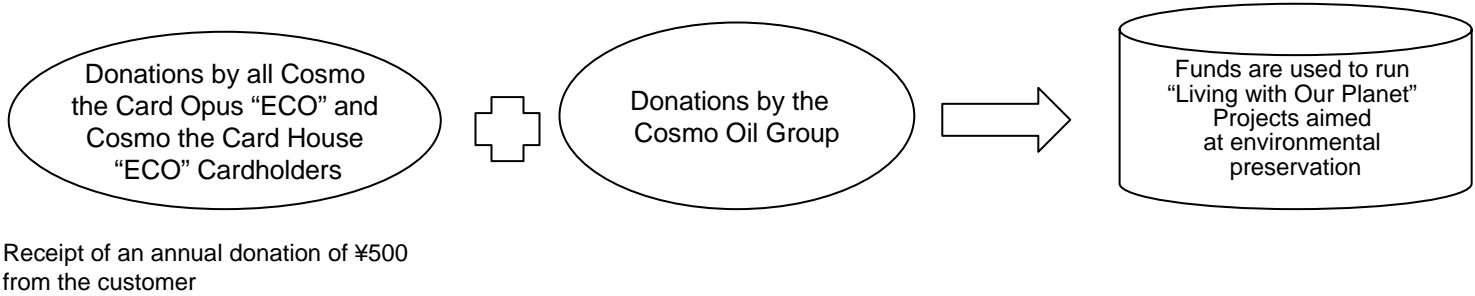

- Note: In addition to that described above, Cosmo Oil will send to each cardmember the "Cosmo Oil Eco Card Fund Report" on environmental preservation activities and how donations from cardmembers will be used.
→ Please refer to Cosmo The Card House

NEW

EcoPower Co., Ltd.

In March 2010, Cosmo Oil acquired all the shares (98.8%) owned by Ebara Corporation in its wind power generation subsidiary, EcoPower Co., Ltd. ("EcoPower"). EcoPower owns wind turbines in wind-rich areas, mainly in Tohoku and Hokkaido. Since 2004, Cosmo Oil has operated the Cosmo Oil Sakata Wind Power Plant (1,500 kw), a wind turbine in Sakata City, Yamagata Prefecture.

<Outline of Eco Power >

- Number of sites for power generation: 25
- Number of units: 130 (as of March 31, 2010)
- Total power generating capacity: 147,000 kw (as of March 31, 2010)

FCC (Fluid Catalytic Cracking Unit)

FCC stands for fluid catalytic cracking unit.

This is a secondary decomposition unit designed to produce a larger quantity of lighter fuel oil fractions (mainly the gasoline fraction).

F Index

An index that dealers use to manage their SSs (or to raise their cost awareness)

The primary objective of introducing this index is to have each dealer understand the ratio of the gross margin of sales of the value added merchandise (including statutory car inspection, lubricating oil change, car wash, tires, batteries and accessories and other services and products) to labor cost to draw their greater attention to cost.

An SS with a larger index would be stronger with value added sales.

$$\text{Calculation method} = \frac{\text{Value added gross margin}}{\text{Labor cost}} \times 100$$

E.x., F Index value of more than 100%: A value added gross margin is offset by labor cost.

F Index value of more than 120%: Labor is more than offset by a value added gross margin. = Strong SS.

GTL (Gas To Liquid)

Liquefied fuel oil manufactured based on natural gas.

It includes almost no sulfur or any other impurities, so that it is expected to provide one of the clean energy resources in the future.

NEW

HC Petrochem Co., Ltd.

This is an equal joint venture company that Cosmo Oil established with Hyundai Oilbank Co., Ltd. (HDO) in November 2009. Using a paraxylene plant (with a production capacity of 380,000 tonnes per year) assigned by HDO, HC Petrochem started manufacturing and marketing paraxylene in February 2010. There are plans to build a new plant (with a production capacity of 800,000 tonnes per year) in 2013.

→ Please refer to “Hyundai Oilbank Co., Ltd. (HDO).”

Heavy Fuel Oil Desulfurization Units (Direct and Indirect)

Units designed to recover sulfur from what is in the bottom (or heavy fuel oil) of the atmospheric distillation unit

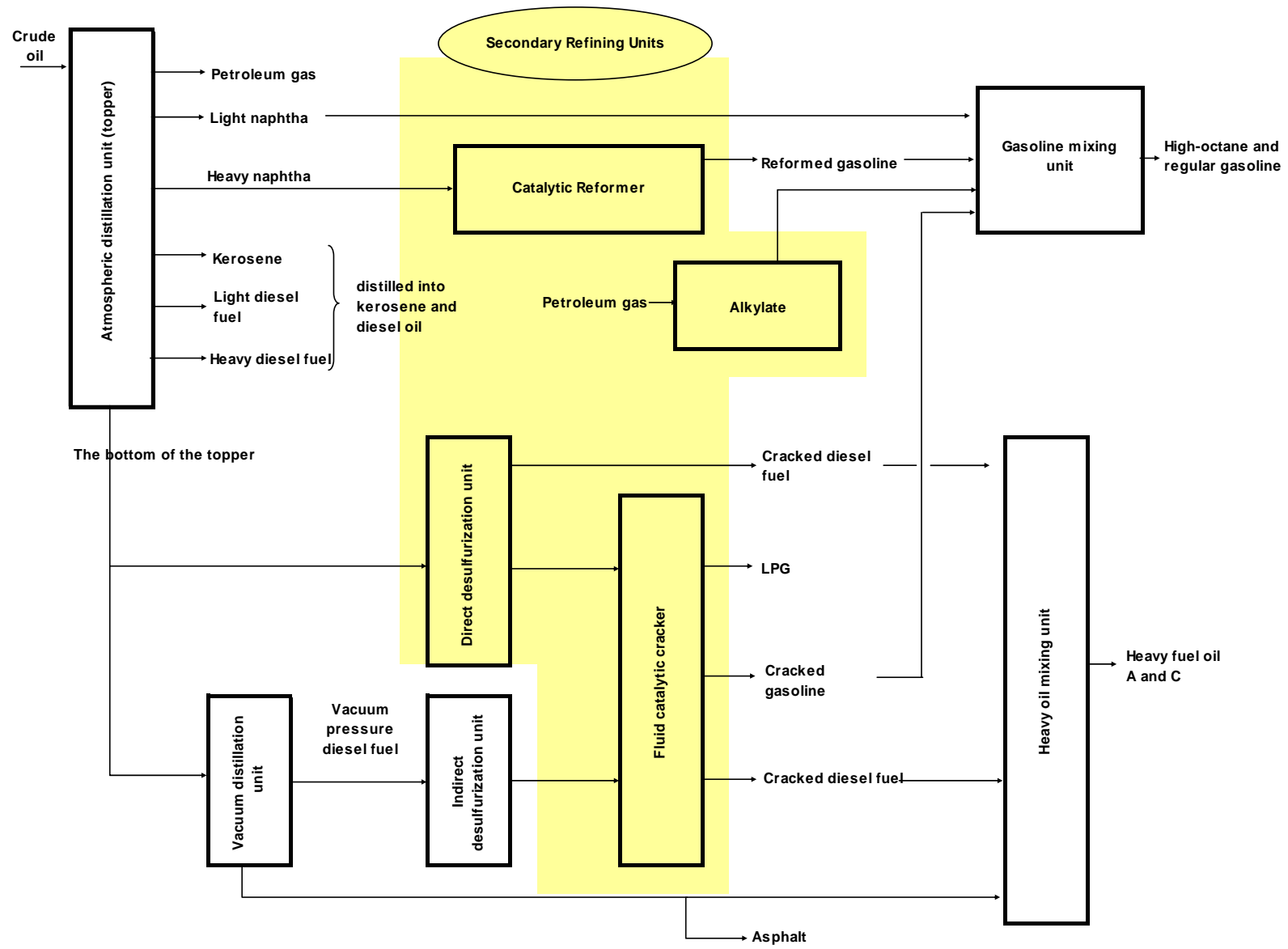

Heavy-Lighter Crude Oil Price Gap

It refers to a price gap between heavy crude oil and light crude oil. As this price gap has been becoming wider these years, a refinery is expected to increase its competitiveness if it has facilities capable of cracking lower-priced heavy crude oil.

(\$ /API / B)

	1995	2000	2003	2004	2005	2006	2007	2008	2009
Heavy-lighter crude oil price gap (JET-HSC)	0.15	0.2	0.14	0.44	0.72	0.75	0.74	0.92	0.26

Hyundai Oilbank Co., Ltd. (HDO)

HDO is an oil refining and marketing company based in the Republic of Korea. Established in 1964, HDO processes crude oil at 390,000 barrels a day and markets fuel oil products with an about 19% share in the domestic market.

As part of its joint projects with IPIC, Cosmo Oil in April 2008 signed a memorandum of understanding for comprehensive and strategic cooperation of the oil business with HDO. In June 2009, the two parties signed a memorandum of agreement in relation to the establishment of a joint venture company (JVC) for para-xylene business collaboration and in October 2009, the parties signed a memorandum of agreement for the establishment of the JVC to undertake the para-xylene business. Cosmo Oil and HDO established a joint venture company (HC Petrochem Co., Ltd.) in November 2009.

→ Please refer to “HC Petrochem Co., Ltd.”

※ Visualized Concept for Olefinic and Aromatic Products

Low-cost raw material makes the business highly competitive. New entrants into facilities

Leading ethylene manufacturing facility in Asia

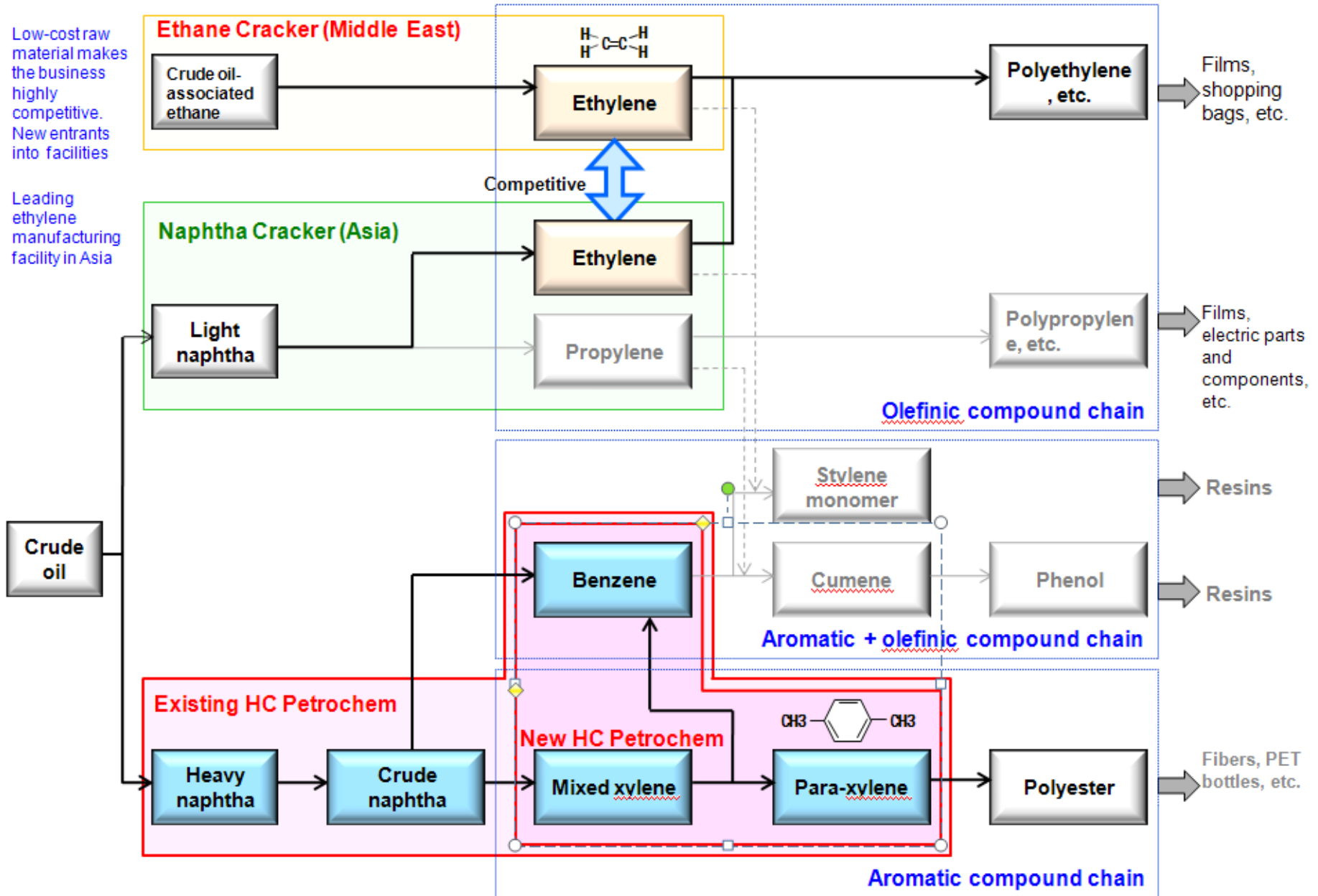

The red framed indicates the scope of business done by HC Petrochem.

※ Para-xylene manufacturing facility structure in the JV business:

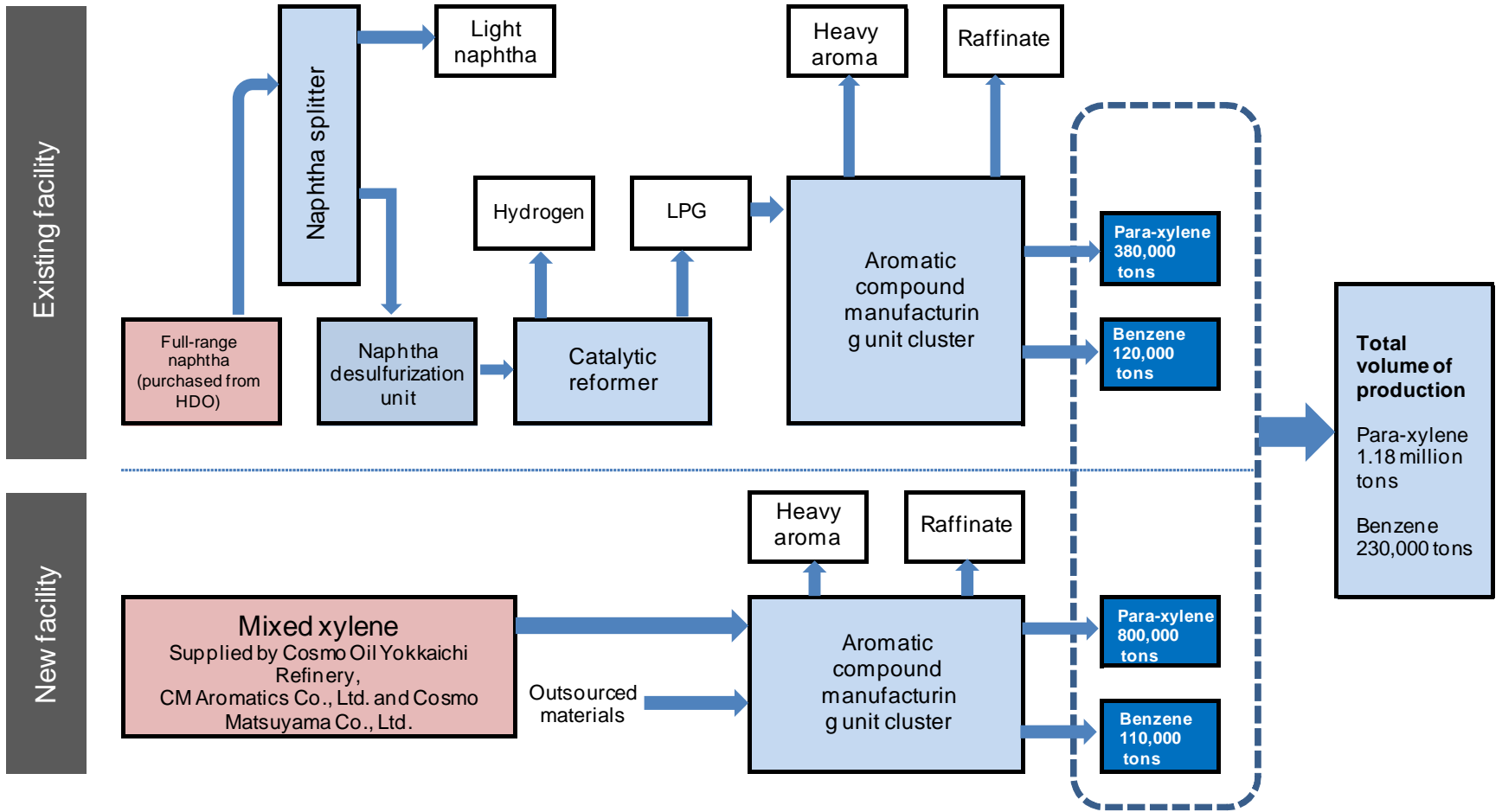

IPIC

Established in 1984, International Petroleum Investment Company is a wholly owned energy-related investment subsidiary of the Emirate of Abu Dhabi. IPIC is specialized in making long-term investments in oil and gas-related businesses outside Abu Dhabi. It owns about 20% of Cosmo Oil shares by accepting a third-party allotment offered by Cosmo Oil.

IPP (Independent Power Producer)

Electricity wholesale business

Cosmo Oil has built a 200,000-kw power station adjacent to its Yokkaichi Oil Refinery, currently supplying electric power to Chubu Electric Power Co. starting from July 2003.

Light-Heavy Distillate Product Price Gap

It refers to a price gap between light distillate product, or oil distillates (such as gasoline, kerosene, diesel fuel, jet fuel, etc.) and heavy distillate product, or heavy fuel oil. A refinery is expected to increase its competitiveness if it can improve rates of producing more highly value-added lighter distillates.

(\$ / BBL)

	2001	2002	2003	2004	2005	2006	2007	2008	2009
Light-heavy distillate product price gap (JET FUEL-HSC)	6.60	5.80	8.00	22.50	27.00	32.00	32.08	36.95	12.07

Market-Linked Pricing Formula Plans (revised in April 2010)

Cosmo Oil has, since April 2009, introduced plans to ensure fair and transparent wholesale prices and to better respond to changes in the market. Wholesale prices are determined based on the following plans, revised in April 2010:

1. 100% market-linked
2. 50% market-linked + 50% crude oil cost

The floor value is also set as the “crude oil price + petroleum tax + in-house fuel cost + refining cost.”

MASDAR

An Abu Dhabi governmental organization of United Arab Emirates.

MASDAR is currently building “MASDAR CITY,” a futuristic city aimed at reducing CO2 emissions down to zero, within Abu Dhabi.

Cosmo Oil signed a joint research and development agreement with Masdar on concentrated solar power (CSP) generation. The necessary funds for joint R&D were provided by the two parties on a 50-50 basis, while the technologies are from the Tokyo Institute of Technology. In October 2009, a demonstration plant was built in Masdar City, where

testing

is now taking place.

Mileage, Mile (Cosmo Gasoline Mileage)

- A frequent customer program allowing purchasers to earn miles—depending on the purchased amounts of automotive

fuels, kerosene, car care products and services—and then to redeem these miles for premiums.

- The program helps increase car care product sales, as well as automobile fuel sales.

- The program encourages customers to visit Cosmo Oil SSs on a continued basis, as well as to use their Cosmo The Card functions.

Mixed Xylene

A raw material used to manufacture para-xylene. Mixed xylene is mainly produced based on reformat (base material for gasoline) that is manufactured by an oil company.

→ Please refer to “Para-xylene.”

Number of Cards in Force

The net number of “Cosmo The Card” cardmembers after the deduction of the number of ex-cardmembers.
The actual number of cardmembers as of today.

Para-Xylene (PX)

Aromatic compounds that are used to manufacture PET bottles and polyester textile products.

-Production Process from Crude Oil to Product .

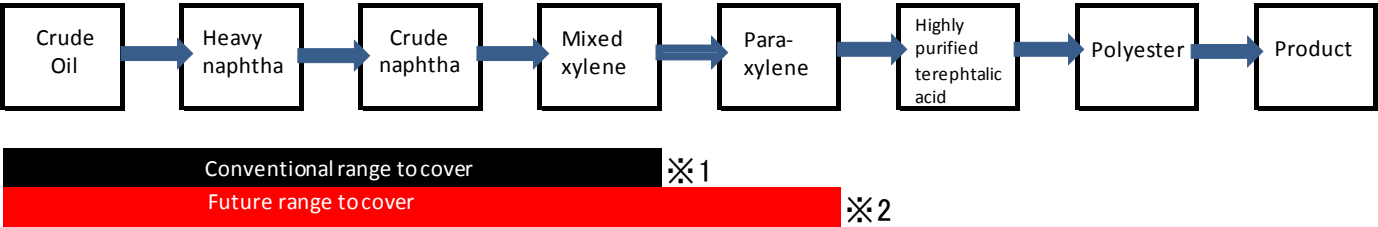

- ※1 Please refer to “CM Aromatics Co., Ltd.”
- ※2 Please refer to “Hyundai Oilbank Co., Ltd.”
- ※3 Please refer to “HC Petrochem Co., Ltd.”

Polysilicon

Highly purified polycrystalline silicon used to make crystalline silicon solar cells.

It is fabricated by processing metallurgical silicon (with purity of 98-99% mainly produced in China) in a variety of fabrication methods to purify it.

The purity of polysilicon required for semiconductors is 11-Nine (99.999999999%) and that for solar photovoltaic (PV) panels is 6-Nine (99.9999%) (according to NEDO information).

The increasingly wider acceptance of solar cells is not being matched by the polysilicon supply. Thus, there has been a tight supply situation of polysilicon in recent years.

Sales Unit, or SS Sales Unit

A monthly sales volume of automobile fuel oil per SS

SS NV Index

This refers to a management evaluation index that provides navigation for SS operators to strengthen their management of SSs (or to build the management basis to improve profitability even if they face such an unfavorable business environment that may reduce operating margins).

The primary objective of the introduction of this index is to have SS operators understand the management policy of minimizing costs to operate an SS, while maximizing a value added gross margin (to be earned from selling statutory car inspection, lubricating oil change, car wash and other services and tires, batteries and accessories and other products) and gasoline and diesel fuel sales.

A dealer would become stronger if it achieves a smaller index value (or even minus figures).

Minimize SS operating expenses

Calculation method =
$$\frac{\text{Direct SS operating expenses} - (\text{Value added gross margin} + \text{Kerosene gross margin})}{\text{Automobile fuel (gasoline + diesel fuel) sales volume}}$$

Maximize a combined non-fuel gross margin

Maximize a combined fuel sales volume

Sulfur-Free Gasoline and Diesel Fuel

Gasoline and diesel fuel containing 10 ppm of sulfur or less, respectively.

Topper

An atmospheric distillation unit. Generally speaking, the crude oil processing capacity of an oil refinery is represented by its topper's processing capacity per day.

Total Number of Cards Issued

The cumulative number of "Cosmo The Card" cards issued so far, including the number of cardmembers who have been withdrawn.

NEW

Wind power generation

→ Please refer to "EcoPower Co., Ltd."